

**OPERATING MANUAL**  
**FOR**  
**STREAM SELECTOR**

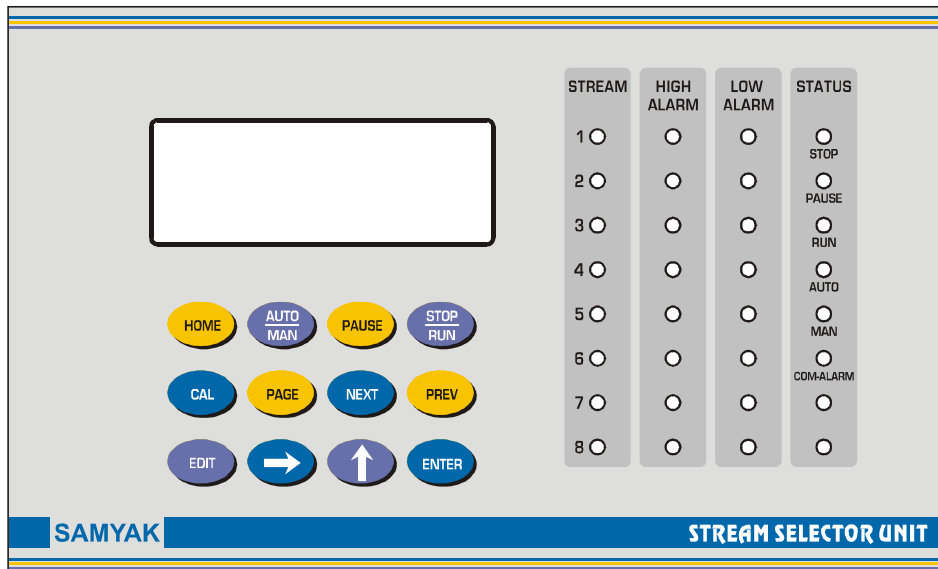

**Manufactured By:**

**SAMYAK INSTRUMENTATION PVT. LTD.**

F-4 Memnagar complex, Opp. Petrol Pump Memnagar, Ahmedabad, India-380 052

Phone: +91-79-2749 5500/5600 FAX: +91-79-27417997

URL: <http://www.samyak.com> Email [sales@samyak.co.in](mailto:sales@samyak.co.in)

**INDEX**

**CHAPTER 1 ..... 3**

**1.1 INTRODUCTION ..... 3**

**CHAPTER 2 ..... 4**

**2.1 SYSTEM DESCRIPTION ..... 4**

**2.2 HARDWARE DESCRIPTION ..... 5**

**2.3 INSTALLATION GUIDE..... 7**

**CHAPTER 3 OPERATING DETAILS..... 8**

**3.1 DISPLAY & KEYBOARD ..... 8**

**3.2 EDIT MODE ..... 9**

**CALIBRATION MODE ..... 11**

**3.3 HOW TO ENTER/MODIFY PARAMETER VALUE ..... 14**

**1 RUN MODE..... 14**

**2 STOP MODE..... 14**

**3.4 RUN MODE..... 15**

**3.4.1 MANUAL MODE ..... 15**

**3.4.2 AUTO MODE..... 16**

**IN PULSE MODE..... 16**

**IN TIME MODE..... 16**

**3.5 CALIBRATION MODE ..... 17**

**3.5.1 INPUT CALIBRATION ..... 19**

**3.5.2 OUTPUT CALIBRATION: ..... 19**

**3.12 FLOW CHECK LOGIC:..... 22**

**CHAPTER 4 ..... 23**

**4.2 TERMINAL DETAILS ..... 24**

**CHAPTER 1****1.1 INTRODUCTION**

This STREAM SELECTOR UNIT is upgraded version of Samyak make stream selector. The unit has 20 characters x 4 lines LCD. This makes it more users' friendly. It is based on a popular 8-bit Microcontroller. The system is designed to control stream selection of up to eight-stream system using its Relay outputs and sync Input or Timer. It also generates Sample and Hold analog outputs for each channel.

**1.2 SPECIFICATIONS:**

1. No. of Streams	Up to 8
2. Mains supply	110-230V AC +/- 10% Single phase, 50 Hz Nominal
3. Key board	12 keys keypad
4. Display	20 * 4 LCD display 32 Discrete LEDs for Relay/process status Indication
<b>5. Relays</b>	
For stream selection	8 Powered relay contacts 8 Potential free contacts
For high Alarm & Low Alarm	8 Powered contact 8 Potential free contacts
For common alarm	1 Powered relay contacts 1 Potential free contacts
Total No. Of relays Contact rating	24 2A/250 AC, Resistive
6. Digital Inputs	4
7. Analog Input	1 no. (4-20 mA)
8. Analog Output	8 Channels (one for each stream): 4 to 20mA Latched Output
9. Dimension	Outer: 270mm (W) x 133.5mm (H) x 260mm (D) Weight: 4Kgs Panel cut-out: 228 mm (W) x 133.5 mm (H)
10. Enclosure	General purpose Panel Mount Made up of Aluminum
11. Serial communication	RS 232

## CHAPTER 2

### 2.1 SYSTEM DESCRIPTION

The system is based on an 8-bit micro-controller. It is to be used for selecting one of the EIGHT streams in accordance with SYNC. Pulse from Analyser if trigger mode is Pulse. Stream selection will be according to pre-programmed timings if trigger mode selected is TIME.

With the help of the keypad and display on front, the system allows to set and modify following parameters of each individual stream.

1. Full scale value for Scaling analog input
2. Skip/Un skip a stream
3. Stream On Time
4. Power On status
5. Alarm set-points

In pulse mode the system allows to skip/unskip specified stream and in time mode if value of Stream On time is programmed as Zero, it is skipped.

When the system is put in RUN mode, thro' front keypad, the sequence is executed. The relays' contacts are switched ON and OFF as per the predefined sequence.

The Powered contacts will be used to switch on and OFF SOVs fitted in the system. Potential free contacts for each relay are provided for remote status indication.

Alarm relays are also switched on and off as per the input from the analyzer.

Analog input is continuously sampled. Value of analog input is continuously displayed in RUN mode. When PAGE key is pressed, latched value for each stream is displayed for stream 1 to 8 respectively. Analog output for each stream is updated after its sampling & analysis is completed.

## **2.2 HARDWARE DESCRIPTION**

The unit has only order type's hardware.

Construction of the system is modular. The system consists of:

- CPU CARD
- Front panel (KB/Display)
- Power Supply card
- Relay cards
- Analog I/O cards

### **2.2.1 CPU CARD**

This is based on a single chip controller. The CPU card has interface for 12 keys keypad organized in 4\*3 matrixes.

It also supports 20 characters x 4 lines LCD display. The configuration data (Timer value and other parameters) are stored in non-volatile RAM. Battery is not required for retention of data.

Watch dog circuit is incorporated on the CPU card to prevent malfunctioning of the system due to external noise thro' power supply or any other source. If the CPU starts malfunctioning, the watch dog circuit resets it and system will be brought to its Power On status. In such conditions, operator has to restart the operation by keyboard if required.

The card is fitted on the backside of the front panel on four fixing screws with nuts.

### **2.2.2 POWER SUPPLY CARD**

This card provides regulated DC voltages to various cards of the system. It is SMPS. Voltages generated on the card are: +5V/500mA, +12V/500mA & +24V/500mA All the supplies are isolated from each other.

Operating voltage is 110-230VAC +/-10%.

Three terminals (three male/female type) are mounted on the card to apply mains power.

The card also has provision for four digital inputs. One of the digital inputs is configured as Sync Input. All inputs should be from potential free contacts.

Power supply card is connected to CPU card thro' 20-pin FRC cable. Supply to analog I/O cards is given thro' 2-3 pin relamate connector.

### **2.2.3 Relay Card**

The Four cards contain six relays of 2 C/O type. Six powered contacts and six potential free contacts are available on backside thro' a 19-pin two piece connector.

The one card contains two relays of 2 C/O type. Two powered contacts and two potential free contacts are available on backside thro' a 19-pin two piece connector.

All relays are 2 C/O type, 12V DC operated, having contact rating of 2A, 250V.

There are four such cards in the system. All cards are identical. They are connected with CPU card thro' a special FRC cable.

### **2.2.4 Analog Input Output Card**

This card contains one analog input and up to eight analog outputs. The input and outputs are current type with range of 4 to 20mA. All the input and Outputs are isolated from each other.

Analog input is terminated in a 250 ohm resistor.

The card has a 19-pin two-piece/screw type connector accessible from back panel.

The card is connected with CPU card by a 20-core FRC cable/connector. +24VDC supply is given to the card from a 3-pin cable from Power supply card.

### **2.2.5 BACK PANEL**

Male Connectors from relay card, PS card and Analog input/output cards are accessible from back panel. Mating female connectors are supplied along with the system. These are screw type terminals.

For back panel connection refer Appendix.

### **2.2.6 ENCLOSURE**

Enclosure is made-up of aluminum. Its outer covers are powder coated in black colour. The internal card frame is of aluminum-extruded profiles. The various cards are fixed with the profile thro' card extractor and retainer set on card guides.

### 2.2.7 FRONT PANEL

Front of the instrument is fitted thro' decorative screws. To open the front you don't need screw driver. Rotate the pullout knobs to disengage the front.

On the front there are various LEDs indicating status of process and status of relays. When relay is on, its corresponding LED on the front will be on. Process status indicators:

Stop	Pause	Run	Auto	Manual	Common Alarm
Stream	Hi Alarm	Lo Alarm			

It has a 12-key membrane keypad. This keypad is connected with CPU card thro' a 20pin FRC type connector.

The FRONT board discrete LEDs for status indication. 3mm red LEDs on the right hand side of the front panel indicate (Stream & Alarm) status.

### 2.3 INSTALLATION GUIDE









- Unpack the instrument from the packing box carefully.
- Mount the instrument in the panel cutout of **228mm x 133.5mm**.
- Fix the instrument with the panel using four nos. of 8mm screw from the front on it's side angles
- Horizontal Channels should be provided inside the panel for the additional support of the Instrument.
- All the electrical connections to be done at the back panel of the unit using spade lugs. Refer the Appendix for back panel layout.
- Make sure that no wire is connected loosely to avoid generation of spark and RFI. Connect mains cord on the back panel on the Phase, Neutral and Earth terminals.
- Earth the instrument properly.
- Some of the contacts are powered. Hence don't touch any terminal directly when power is applied to the instrument. Whenever any connection is to be made or removed from the unit, always switch off the power.

**CHAPTER 3 OPERATING DETAILS**



The following paragraphs give detailed description of how to operate the unit. For efficient use of the instrument one must study and understand this section.

**3.1 Display & Keyboard**

The system has 20 characters x 4 lines LCD display. There are statuses LEDs showing process status and relay status. The system has 12 key membrane keypad organized as 4 x 3 matrix. List of keys and their functions:

<b>KEYS</b>	<b>FUNCTION</b>
	For Factory Setting
	Toggle between Auto and Manual mode
	When process is Running, Pause it in Auto/Run mode. The timer stops counting. On/Off status of relays remain unchanged
	Toggle the operation between Stop and Run Mode in Auto/man mode
	Enter into calibration mode through Password 1234
	Enter into Parameter Edit page through Password 0101 and see status Latched Value & current output in Run mode
	Go to the next parameter in selected page
	Go to the previous parameter in selected page
	Enter into edit mode



	Select digit
	Increment selected Digit value
	Save new data and Terminate Edit mode

**Whenever mains is switched on to the unit:**

The process will always start in Auto mode. Refer ‘RUN’ mode of operation for execution/operation of the instrument.

All the Analog outputs will be at 4.00 mA at Power ON. All the alarms will be in reset condition.

**There are two modes of operation: STOP and RUN mode.**

Before entering into RUN mode, one can select Stream no. When ‘Edit’ key is pressed, the data field of display starts flashing. Use increment key to select desired stream no. Stream number ranges from 1 to 8.

After setting desired value, press Enter key. Display stops flashing.

Now one can either go to Stop mode or Run mode. If you want to start the process, press ‘RUN’ key. Program will start running in Auto or Manual mode. Select the Auto/Man. Mode using Auto/Man key.

**3.2 Edit Mode**

In this mode user can verify or update various parameters. One can perform this mode only when the instrument is in Stop mode.

Press ‘PAGE’ key to enter into Parameter edit mode.

The display will show:

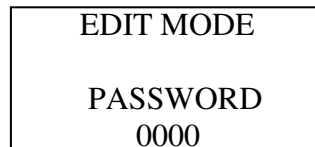

The unit is prompting for Password. Password is a 4-digit no. There are two password.

Operator's Password-1: 0101  
 Operator's Password-2: 3210

If Operator's password-1: 0101 is entered, one can edit the following parameters.

Parameter Description	Display in Edit field	Min Value	Max Value
Password	0000	0101	
Power on mode	STOP/RUN		
FULL scale 1	0000	0000	9999
DELAY TIME	0000		0999
NO SAMPLE TIME	0000	0999	
DP	0	0.001	0
NO OPER DELAY	00	00	99
CHECK FLOW	ENABLE/DISABLE		
FLOW CHECK TIME	0000	00	99
PULSE COUNT	0000	1	14
UNIT 1	%, ppm, ppb,		
UNIT 2	%, ppm, ppb,		
UNIT 3	%, ppm, ppb,		
UNIT 4	%, ppm, ppb,		
STREAM NO.1	0000	0	9999
STREAM NO.2	0000	0	9999
STREAM NO.3	0000	0	9999
STREAM NO.4	0000	0	9999
HIGH ALARM 1	0000	0	9999
HIGH ALARM 2	0000	0	9999
HIGH ALARM 3	0000	0	9999
HIGH ALARM 4	0000	0	9999
Stream 1	SKIP/UNSKIP		
Stream 2	SKIP/UNSKIP		
Stream 3	SKIP/UNSKIP		
Stream 4	SKIP/UNSKIP		

Press 'PAGE' key to enter into Parameter edit mode.

The display will show:

EDIT MODE  PASSWORD 0000
-----------------------------------

The unit is prompting for Password. Password is a 4-digit no. There are two password.

Operator's Password-1: 3210

If Operator's password-1: 3210 is entered, one can edit the following parameters.

Parameter Description	Display in Edit field	Min Value	Max Value
Password	0000		3210
TYPE OF TRIGGER	TIME / PULSE		
DATE	00	00	31
MONTH	00	00	12
YEAR	00	00	99
TIME ;HOUR	00	00	23
TIME;MIN	00	00	59
SERIAL	PRINT/ MODE BUS		
BAUD	19200/9600	9600	19200
PRINT TYPE	KEY/PERIOD/EVENT		
PRINT INTERVAL:MIN	000	000	999
ALARM TIMER:SECONDS	00	00	99
TOC ACTION LIMITE	000	000	999
TOC ALERT LIMITE	000	000	999
HEADER-1			
HEADER-2			
HEADER-3			
HEADER-4			
HEADER-5			
HEADER-6			
HEADER-7			
HEADER-8			

**CALIBRATION MODE**

Press 'CAL' key to enter into Calibration mode

The display will show:

<p>CALIBRATION</p> <p>PASSWORD</p> <p>0000</p>
--

The unit is prompting for Engineer's Password. 1234. Password is a 4-digit no.

One can perform calibration of analog input and Output thro' software using standard source and meter. To start calibration:

- ❖ Enter into calibration mode using Engineer's Password.1234
- ❖ Display will show a page:

*CALIBRATION* INPUT CALIBRATION ← OUTPUT CALIBRATION DEF. OP CALIBRATION
---

Press PREV & NEXT key to move arrow, up and down. If enter key is pressed pages of input calibration, output calibration & default output calibration are opened corresponding to the position of the arrow.

- ❖ In case of input calibration page following parameters will be displayed on the display after each depression of 'NEXT' or 'PREV' key.

CALZERO 1 & CALSPAN 1

- ❖ In case of output calibration page following parameters will be displayed on the display after each depression of 'NEXT' or 'PREV' key.

OUTZERO 1  
OUTSPAN 1

OUTZERO 2  
OUTSPAN 2

OUTZERO 3  
OUTSPAN 3

OUTZERO 4  
OUTSPAN 4

Press 'CAL' key to enter into Calibration mode

The display will show:

CALIBRATION
PASSWORD
0000

The unit is prompting for Engineer's Password. 1234. Password is a 4-digit no.

If engineer's password is entered, one can perform calibration of analog input and analog output thro' software using standard source & meter. This is not allowed using operator's Password.

Enter the correct password using data entry keys (Digit select and Increment Key). When 'Enter' key is pressed, data field of display stops flashing. Validity of Password is checked. If wrong password is entered the unit again prompts for correct Password.

If correct password is entered, then the display of data field becomes steady. Now press PAGE key.

Now press 'Edit' key, if you want to modify the parameter. Data field starts flashing. Use increment and digit select key to set parameter. Pressing the 'NEXT' key again & again will display next parameter in the sequence.

NEXT and PREV key is used to select next and previous parameter in calibration and parameter edit mode.

Following the above process, one can select any of the above listed parameters. When the parameter is selected its current value is being displayed.

If one wants to modify, press 'Edit' key to change it. When 'Edit' key is pressed, the display will start flashing indicating that you can modify the digit.

Press 'Enter' key when the new desired value is set. Display will stop flashing.

One can come out of the data entry/programming mode, by pressing 'Stop/Run' key in between. The system will start from first stream in Auto mode and from selected Stream in Manual mode.

If no other operation is preformed, one can still enter into Edit mode without entering password again within 60 seconds. But if any other operation like 'Run' in Auto mode or any other operation in manual mode is performed, you cannot enter into Data entry mode without entering correct Password.

If no key is pressed for more than 60 seconds, the Data entry/programming mode is terminated automatically and display will show:

STREAM SELECTOR VER 3.11 SELECTED PROBE N
---

N = currently selected stream no 1 to 8

To enter into edit mode, you will have to enter Password again.

**3.3 How To Enter/Modify Parameter Value**

Use Digit select (→), Increment (↑) and ‘Enter’ key to enter or modify any numeric data.



When in data entry/edit mode, the selected digit will be flashing.

Press increment key, the no. at the selected digit position will increment from 0 to 9 and rolls back to 0 when it reaches at 9.

Once desired digit is set, press digit select key (Right arrow) to select next digit. The next selected digit will flash. Set it to desired value as per the above step.

Once all the digits are set, press ‘Enter’ key. The display will stop flashing.

**POWER ON MODE**

The Power On status of the unit saved last status run or stop.

**1 RUN MODE**

If, the unit is configured for this mode, then whenever Power is switched on to the Unit, it will start executing the sequence in Auto OR Manual mode.

**2 STOP MODE**

If, the unit is configured for this mode, then whenever Power is switched on to the Unit, it will be in Stopped state in Auto mode OR Manual mode.

**3.4 RUN MODE**

The modes in which the process can be RUN: Auto and Manual. When the process is in stop mode, one can select Auto or manual mode by pressing ‘Auto/Man’ key. Every time this key is pressed, the mode of the process is toggled between Auto and Manual. An LED will glow for the Mode getting selected. Now we will explain each mode in detail:

**3.4.1 MANUAL MODE**

When in this mode, the LED for Manual mode will be on. To start the operation, one has to select stream.

STREAM SELECTOR VER 3.11  SELECTED PROBE N
---

N = data field (stream no 1 to 8)

Press ‘Edit’ key. The stream no. in data field will start flashing. Select the desired stream using Increment key. Press ‘Enter’ key, when desired stream is set. Display will stop flashing.

Now one can switch on the relay of the selected stream by pressing ‘RUN’ key. The display will show

RUN MODE		
STREAM	TIME	INPUT
Pn	tc	ip

Pn = running stream  
 tc = elapsed time in second  
 ip = analog input value

Once in ‘RUN’ mode, ‘RUN’ LED will glow. The relay of the selected stream will be ON. Page will display Selected Stream no. (Pn) and elapsed time tc for that stream. (Up counting).

The display will also show engineering value of analog input.

If analog output current monitoring is desired press PAGE key in RUN mode.

Analog output equal to input will be available at the output terminals of the selected stream (after completion of sample time) and at the output terminals of the common (tracking) channel.

Analog Output at other channels will be maintained to last Latch value.

**3.4.2 AUTO MODE**

When in stop condition, one can enter into Auto mode. When Auto mode is selected ‘Auto’ LED will be ON. System will always starts from first stream.

If you want to start RUN, press ‘RUN’ key. The following sequence will be started:

Initially the display will show

RUN MODE		
STREAM	TIME	INPUT
Pn	tc	ip

- Pn = running stream
- tc = Timer value in time mode  
& Elapsed time in pulse mode
- ip = Engineering value of analog input

Relay for running stream will be on, to allow the sample to flow in.

**IN PULSE MODE**

The system will wait for sync. Pulse from Analyzer to go high (+12V). As soon as Sync. Pulse goes high; the system will be in sample mode for the selected stream. Once in ‘RUN’ mode, ‘RUN’ LED will glow. The relay of the selected stream will be ON. Page will display Selected Stream no. (Pn) and elapsed time tc for that stream. (Up counting). When reach value of timer tc The relay for the selected stream is switched off.

Now the system will wait for sync. Pulse from Analyzer to go low. As soon as Sync. Pulse goes low; the system considers the stream to be in Analysis mode Relay for next unskipped stream is switched on. Now the system will again wait for sync. Pulse from Analyzer to go high. As soon as Sync. Pulse goes high; the system considers the stream data is latched in selected stream. Cycle is repeated continuously until stop is pressed.

**IN TIME MODE**

If you want to start RUN, press ‘RUN’ key. The process will start from First stream. The relay for the running stream will be on. The programmed timer value will be displayed in



the data field. It will start down counting and the remaining time value for the 'tc' will be displayed in the Data field of the display.

When the timer (tc) value becomes zero. The currently selected stream relay will be switched OFF. The next stream timings will start. The cycle will go up to the last stream. Once cycle for last stream is executed, it will go to first stream.

If timer value is programmed as '0', the stream will be skipped.

One can terminate the sequence by pressing 'Stop' key. All the relays will be switched OFF.

If one wants to 'Pause' the process, he can press 'Pause' key. When the 'Pause' key is pressed, Pause LED will be on. The timer stops advancing. The relay of the current stream is 'off' but status of the relays for Hi Alarm is maintained as it was before pausing.

### **3.5 CALIBRATION MODE**

One can perform calibration of analog input and Output thro' software using standard source and meter. To start calibration:

- ❖ Enter into calibration mode using Engineer's Password.
- ❖ Display will show a page:

<p>*CALIBRATION* INPUT CALIBRATION ← OUTPUT CALIBRATION DEF. OP CALIBRATION</p>
---

Press PREV & NEXT key to move arrow, up and down. If enter key is pressed pages of input calibration, output calibration & default output calibration are opened corresponding to the position of the arrow.

- ❖ In case of input calibration page following parameters will be displayed on the display after each depression of 'NEXT' or 'PREV' key.

CALZERO 1 & CALSPAN 1

- ❖ In case of output calibration page following parameters will be displayed on the display after each depression of 'NEXT' or 'PREV' key.

OUTZERO 1  
OUTSPAN 1

OUTZERO 2  
OUTSPAN 2

OUTZERO 3  
OUTSPAN 3

OUTZERO 4  
OUTSPAN 4

OUTZERO 5  
OUTSPAN 5

OUTZERO 6  
OUTSPAN 6

OUTZERO 7  
OUTSPAN 7

OUTZERO 8  
OUTSPAN 8

- ❖ In case of default calibration page display will be

DEF. OP CALIBRATION  
YES/NO

Pressing EDIT key and then Increment key, YES and NO will be displayed alternatively. Selecting YES, if Enter key is pressed Values for all analog output calibration settings will be initialized to default value.

- ❖ In case of default calibration page display will be

OUTPUT SET TO ZERO  
YES/NO

Pressing EDIT key and then Increment key, YES and NO will be displayed alternatively. Selecting YES, if Enter key is pressed Values for all analog output will be 4.00 ma values.

### 3.5.1 INPUT CALIBRATION

- ❖ Connect output of a standard 4-20 mA current source at the analog input terminals of the unit.
- ❖ Apply 4.00 mA input and monitor data displayed against parameter 'CALZERO1'.
- ❖ Press Edit Key & then Enter key to accept this as a zero reference.
- ❖ Now apply 20ma at the input.
- ❖ Select next parameter 'CALSPAN1'.
- ❖ Monitor display. When display is steady,
- ❖ Press Edit Key & then enter key. The displayed value will be stored as fullscale reference.
- ❖ These zero and fullscale values are stored in NVRAM.
- ❖ The input is linearly scaled between these two values.

### 3.5.2 OUTPUT CALIBRATION:

#### STREAM: 1

#### ZERO CALIBRATION:

- ❖ Connect a standard meter at the analog output terminals of channel 1.
- ❖ Apply 4.00 ma input.
- ❖ Select parameter 'OUTZERO1'.
- ❖ Monitor current output on the meter.
- ❖ Press Edit Key.
- ❖ It should be 4.00 mA.
- ❖ Use '↑' key to increase output.
- ❖ Use '→' key to decrease the output.
- ❖ Using these two keys to set the output at 4.00 mA and then press 'enter' key.

#### FULLSCALE CALIBRATION:

- ❖ Apply 20.00ma at input.
- ❖ Select parameter 'OUTSPAN1'.
- ❖ Monitor current output on the meter.
- ❖ It should be 20.00 mA.
- ❖ Press Edit Key.
- ❖ Use '↑' key to increase output.
- ❖ Use '→' key to decrease the output.

❖ Using these two keys to set the output at 20.00 mA and then press 'enter' key. Calibration for output of other streams can be carried out using above procedure by selecting the respective parameters and monitoring their respective output terminals.

### **3.6 CURRENT (ANALOG) INPUT AND OUTPUT**

The stream selector takes 4 to 20 mA as current input from Analyzer. This is fed to V to F converter on Analog I/O card.

If system is in Run mode, sampled value for current input below INPUT is displayed in the run mode status page of the display.

To display hold analog current value, press PAGE key in run mode. It will display a page containing hold output current for six streams and press NEXT key for the value of seventh stream.

There are eight channels of Analog output. Their output is from of 4.00 to 20.0 mA. These are sample & hold type outputs.

Output of a particular Analog output channel is updated according to output updation type. If output updation type is 'continuous' Output of a particular Analog output channel is updated continuously after setting delay time and when it is' On stream change 'Output of a particular Analog output channel is updated after sampling for that particular stream is completed after setting delay time.

When stream is change over before setting value of no sample time output channel is no updated

### **3.7 ALARM LOGIC:**

The Stream selector is having logic to generate High and Low alarm output for each channel by comparing input with the High and Low alarm set points.

Whenever sampling of a stream is over, the corresponding alarm output is updated. When a stream is deselected, its alarm relays' condition is maintained till it is sampled again.

One set of Powered and Potential free contact for all the Eight alarm relays are provided on the Back panel of the unit.

One can monitor actual status of the alarm by observation of the LED's of Hi -LoAlarm on front.

### **3.8 DATE & TIME:**

Entering 3210 password will display Type of Trigger parameter; pressing next key will display DATE parameter. Similarly pressing next key will display MONTH, YEAR, HOUR & MINUTE parameter.

**3.9 PRINT MODE:**

SERIAL parameter is to select serial mode i.e. PRINT. Selecting PRINT will print the data (in printer). Pressing next key will display BAUD parameter. Here, 19200 & 9600 baud rate selection is selected to print the data on that much baud rate.

Three different printing mode is available; i.e. KEY, PERIOD & EVENT.

In AUTO mode, On selecting KEY in PRINT TYPE parameter will allow user to print data by pressing ‘Enter key’ in RUN mode. On selecting PERIOD in PRINT TYPE parameter will allow user to print data on regular interval & by entering desire minute for regular print in PRINT INTERVAL parameter, will print after every that much minute. Example ,if 5 minutes is enter in PRINT INTERVAL parameter, than after every 5 minutes it will print data in RUN mode. On selecting EVENT in PRINT TYPE parameter will print data on every change of stream.

In MANUAL mode, KEY & PERIOD type will works similarly like as AUTO mode; In EVENT type whenever Run mode is selected it will print data.

Entering the value in TOC LIMIT parameter, will display that much value in Header. User can print header by pressing ‘Home’ key in RUN mode.

**3.9 ALARM RELAY (BINARY RELAY):**

Whenever stream change over will occurs, alarm relay will turn ON and remain ON till its timer becomes “00”. User can enter desired time (seconds) in ALARM TIMER parameter. When alarm relay will turn ON, “COM-ALARM” LED will also turn ON.

**3.10 ALARM RELAY DETAILS:**

SS2	Details	Remarks
1	Common	Potential Free contact
2	NO	
13	NO	Power contact
3	Common	Potential Free contact
4	NO	
14	NO	Power contact
9	Common	Potential Free contact
10	NO	
17	NO	Power contact

**3.11 TIMING DIAGRAM:**

- Below shown is the timing diagram of Stream selector: -

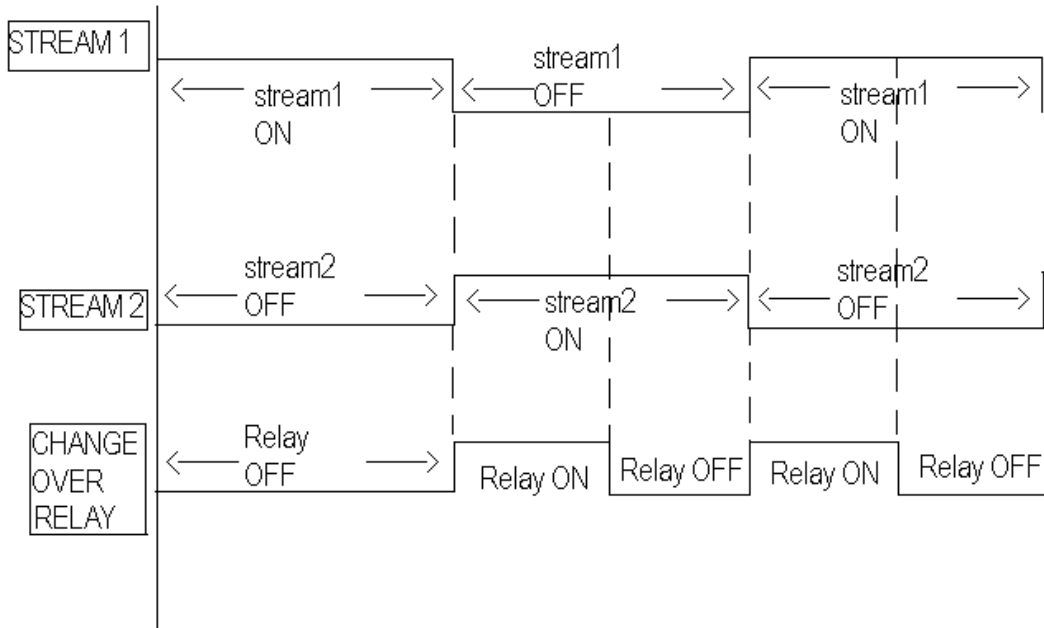

**3.12 FLOW CHECK LOGIC:**

- Flow check logic is for stream 2 only. When CHECK FLOW is DISABLE; then unit will work as regular. will not check flow timer.
- If CHECK FLOW is ENABLE; then after completion of Stream 1 Flow Check timer will start and within Flow check timer if digital input is obtain then Stream 2 timer start and after completion of Stream 2 timer it will work regularly.
- If Flow Check timer is over and digital input is not obtained then it will directly start Stream 3.

## CHAPTER 4

### 4.1 TROUBLE SHOOTING

This section describes how to trouble shoot your scavenging system, if some fault is detected.

*Fault: No display on the front panel.*

- ❖ Check cable between power supply card and the CPU card fitted inside the front panel.
- ❖ Check that +5V supply is available on the CPU card.
- ❖ If +5V does not come, there is a problem with power supply card.
- ❖ Check Mains voltages on the back panel.
- ❖ If mains supply is available, but +5V is not available, check voltages of the at the rectifier input on the PS card.
- ❖ Either for problem in PS card, call factory for assistance.
- ❖ If +5V is available on the CPU card, then there is a problem in the CPU card.

*Fault: Timer and configuration Data is not retained.*

Press the ICs on the socket in CPU card. If the problem is not solved, call factory for assistance.

*Fault: Relay indicator glows, but relay contact not available on back panel.*

- ❖ See that the connectors on back panel are tightly fitted.
- ❖ Check connector between PS card and the relay card.
- ❖ If fault cannot be recovered, call factory for assistance.
- ❖ Check fuse on the relay/power supply card.

*Fault: Analog input indication is not proper.*

Check Analog I/O card.

*Fault: Analog outputs are not proper.*

Check Analog I/O card.

*Fault: Stream selector is in Stop status on Power on/Power failure.*

Check Power On mode being programmed.

**4.2 Terminal Details**

This is back panel terminal details. Terminal no. and the signals terminated on each terminal are given. This detail is useful for interfacing/ Panel wiring

